

Spare Part Information

Ersatzteillinformation



English
Deutsch

Preliminary Spare Part List Thermo Top Pro 120/150
vorläufige Ersatzteilliste Thermo Top Pro 120/150



English
Deutsch

Spare Part Information Thermo Top Pro 120/150

Spare Part Information Thermo Top Pro 120/150

For price requests please refer to actual price list

Preise entnehmen Sie bitte der aktuell gültigen Preisliste.

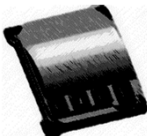
|  | 12V nominal Voltage | 24V nominal Voltage | 12kW Heating Power | 15kW Heating Power | Spare Part List for Thermo Top Pro 120/150 Übersicht Ersatzteile Thermo Top Pro 120/150 | |
|---|--|---------------------|--------------------|--------------------|---|--------------------------------------|
| | | | | | Spare Part Description Ersatzteilbezeichnung | Order number Bestellnummer |
|  | X | | X | | SP HEATER TTP120 12V STD (V12.0001) | 9036983A |
| | | X | X | | SP HEATER TTP120 24V STD (V12.0102) | 9036984A |
| | X | | | X | SP HEATER TTP150 12V STD (V15.0001) | 9036985A |
| | | X | | X | SP HEATER TTP150 24V STD (V15.0102) | 9036986A |
|  | X | | X | | SP ECU TTP120 12V STD (V12.0001) | 9036879A |
| | | X | X | | SP ECU TTP120 24V STD (V12.0102) | 9036880A |
| | X | | | X | SP ECU TTP150 12V STD (V15.0001) | 9036881A |
| | | X | | X | SP ECU TTP150 24V STD (V15.0102) | 9036882A |
| Delivery schedule for Heater and Control units on request | Explanation for Variants: V12.0001 12 kW Heating Power 15 kW Heating Power V12_0001 0: Standard Heating Unit 1: Segment specific heater version 2: Country specific heater version V12.0001 0: 12V 1: 24V V12.0001 01... EOL Table ID | | | | | |



English
Deutsch

Spare Part Information Thermo Top Pro 120/150

Spare Part Information Thermo Top Pro 120/150

For price requests please refer to actual price list

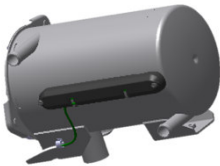
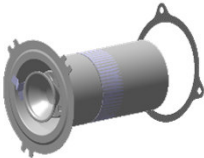
Preise entnehmen Sie bitte der aktuell gültigen Preisliste.

|  | 12V nominal Voltage | 24V nominal Voltage | 12kW Heating Power | 15kW Heating Power | Service Kits Thermo Top Pro 120/150 | |
|---|---------------------|---------------------|--------------------|--------------------|--|----------|
| Spare Part Description <i>Ersatzteilbezeichnung</i> | | | | | Order number <i>Bestellnummer</i> | |
|  | X | | X | | SP BLOWER UNIT ASSEY 12V, 12kW | 9038237A |
| | | X | X | | SP BLOWER UNIT ASSEY 24V, 12kW | 9038240A |
| | X | | | X | SP BLOWER UNIT ASSEY 12V, 15kW | 9038238A |
| | | X | | X | SP BLOWER UNIT ASSEY 24V, 15KW | 9038241A |
|  | X | X | X | X | SP HEAT EXCHANGER, STD | 9036896A |
|  | X | X | X | X | SP BURNER COMPLETE | 9036604A |
|  | X | X | X | X | SP GASKET BURNER - HEAT EXCHANGER TTP150 | 9037217A |
|  | X | X | X | X | SP BAFFLE PLATE | 9036597A |







English
Deutsch

Spare Part Information Thermo Top Pro 120/150

Spare Part Information Thermo Top Pro 120/150

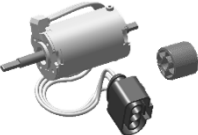
For price requests please refer to actual price list

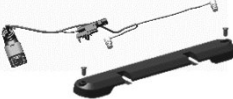
Preise entnehmen Sie bitte der aktuell gültigen Preisliste.

| | 12V nominal Voltage | 24V nominal Voltage | 12kW Heating Power | 15kW Heating Power | Spare Part List for Thermo Top Pro 120/150 Übersicht Ersatzteile Thermo Top Pro 120/150 | |
|---|-------------------------|---------------------|--------------------|--------------------|---|--------------------------------------|
| | | | | | Spare Part Description Ersatzteilbezeichnung | Order number Bestellnummer |
|  | X | | X | X | SP BAG IGNITION SPARK GENERATOR 12V | 9036854A |
| | | X | X | X | SP BAG IGNITION SPARK GENERATOR 24V | 9036855A |
| Includes Ignition spark electrode | | | | | | |
|  | X | X | X | X | SP BAG IGNITION SPARK ELECTRODE | 9036603A |
| | X | X | X | X | SP BAG IGNITION SPARK ELECTRODE (5pcs) | 9037220A |
|  | X | X | X | X | SP NOZZLE | 9036601A |
| | X | X | X | X | SP NOZZLE (5pcs) | 9037219A |
|  | X | | X | X | SP BLOWER MOTOR 12V | 9036856A |
| | | X | X | X | SP BLOWER MOTOR 24V | 9036857A |
| includes Coupling and mounting parts | | | | | | |
|  | X | X | X | X | SP EXHAUST TEMPERATUR SENSOR TTP120/150 | 9036851A |
|  | X | X | X | X | SP TEMPERATUR SENSOR CPL. TTP120/150 | 9036849A |
| | Includes Protection Cap | | | | | |
|  | X | X | X | X | SP PROTECTION CAP SENSOR | 9036848A |





English
Deutsch

Spare Part Information Thermo Top Pro 120/150

Spare Part Information Thermo Top Pro 120/150

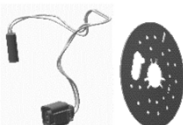
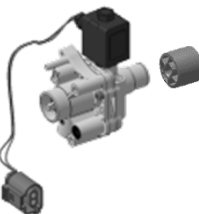
For price requests please refer to actual price list

Preise entnehmen Sie bitte der aktuell gültigen Preisliste.

| | 12V nominal Voltage | | | | 24V nominal Voltage | | | | 12kW Heating Power | | | | 15kW Heating Power | | | | Spare Part List for Thermo Top Pro 120/150 Übersicht Ersatzteile Thermo Top Pro 120/150 | | |
|---|---------------------|---|---|---|---------------------|---|--|---|--------------------|--|--|--|--------------------|--|--|--|--|--|----------|
| | | | | | | | | | | | | | | | | | Spare Part Description Ersatzteilbezeichnung | Order number Bestellnummer | |
|  | X | X | X | X | | | | | | | | | | | | | HEATING CARTRIDGE 12V CPL. | 9036616A | |
| | X | X | X | X | | | | | | | | | | | | | HEATING CARTRIDGE 24V CPL. | 9036608A | |
| includes Mounting Bracket & Buffelplate | | | | | | | | | | | | | | | | | | | |
|  | X | | | | X | | | | | | | | | | | | SP GEAR PUMP ASSEY 12V, 12kW | 9036858A | |
| | X | | | | | | | X | | | | | | | | | SP GEAR PUMP ASSEY 12V, 15kW | 9036859A | |
| | | X | X | | | | | | | | | | | | | | | SP GEAR PUMP ASSEY 24V, 12kW | 9036861A |
| | | X | | | | X | | | | | | | | | | | | SP GEAR PUMP ASSEY 24V, 15KW | 9036862A |
| includes SP Bag coupling and mounting parts | | | | | | | | | | | | | | | | | | | |
|  | X | X | X | X | | | | | | | | | | | | | SP BAG COUPLING | 9036602A | |
| inclusive mounting material | | | | | | | | | | | | | | | | | | | |
|  | X | X | X | X | | | | | | | | | | | | | SP COVER AIR INLET | 9036592A | |
| inclusive mounting material | | | | | | | | | | | | | | | | | | | |
|  | X | X | X | X | | | | | | | | | | | | | SP AIR FAN | 9036593A | |
| inclusive mounting material | | | | | | | | | | | | | | | | | | | |
|  | X | X | X | X | | | | | | | | | | | | | SP AIR BLEDE VALVE | 9036599A | |
| includes Brackets 9035491A | | | | | | | | | | | | | | | | | | | |
|  | X | | | | X | | | | | | | | | | | | SP Circulation Pump U4850, 12V with holder | 9036574B | |
| | | X | X | X | | | | | | | | | | | | | | SP Circulation Pump U4850, 24V with holder | 9036573B |
| includes Brackets 9035491A | | | | | | | | | | | | | | | | | | | |
|  | X | X | X | X | | | | | | | | | | | | | SP Brackets U4850 | 9035491A | |



English
Deutsch

Spare Part Information Thermo Top Pro 120/150

Spare Part Information Thermo Top Pro 120/150

For price requests please refer to actual price list

Preise entnehmen Sie bitte der aktuell gültigen Preisliste.

| | 12V nominal Voltage | 24V nominal Voltage | 12kW Heating Power | 15kW Heating Power | Spare Part List for Thermo Top Pro 120/150 Übersicht Ersatzteile Thermo Top Pro 120/150 Application Parts Einzelteile Applikation | |
|---|---------------------|---------------------|--------------------|--------------------|---|--------------------------------------|
| | | | | | Spare Part Description Ersatzteilbezeichnung | Order number Bestellnummer |
|  | x | x | x | x | WIRING HARNESS VEHICLE TP 120-150 | 9034537A |
|  | x | x | x | x | WIRING HARNESS VEHICLE FAN (L1600) | 1321993A |
|  | x | x | x | x | WIRING HARNESS CIRCULATION PUMP U4850 (L1000) | 9034769B |
|  | x | x | x | x | FUSEHOLDER | 1321992A |
|  | x | | x | x | Bag Electric 12V | 9024914A |
| | | x | x | x | Bag Electric 24V | 9024913A |
|  | x | x | x | x | Connector Diagnose | 9029703A |
|  | x | x | x | x | Kit Connectors TP120/150, complete | 9037223A |









English
Deutsch

Spare Part Information Thermo Top Pro 120/150

Spare Part Information Thermo Top Pro 120/150

For price requests please refer to actual price list

Preise entnehmen Sie bitte der aktuell gültigen Preisliste.

| | 12V nominal Voltage | 24V nominal Voltage | 12kW Heating Power | 15kW Heating Power | Spare Part List for Thermo Top Pro 120/150 Übersicht Ersatzteile Thermo Top Pro 120/150 Application Parts Fuel Einzelteile zur Applikation Kraftsstoff | |
|---|---------------------|---------------------|--------------------|--------------------|--|---|
| | | | | | Spare Part Description <i>Ersatzteilbezeichnung</i> | Order number <i>Bestellnummer</i> |
|  | | | | | BAG FUEL FILTER Connectors TTP 120-150 with Sealing | 9035486A |
|  | | | | | FUEL FILTER CPL with Mounting plate | 9036520A |
|  | | | | | Fuel Exchange Filter KC20 | 9036522A |
|  | | | | | Bag Heating Adapter | 9036523A |
|  | | | | | Temperatur Switch | 9036519A |
|  | | | | | Fuel Extractor 8x6x8 T-FORM | 9035126A |
| | | | | | Fuel Extractor 10x6x10 T-FORM | 9035128A |
| | | | | | Fuel Extractor 12x6x12 T-FORM | 9035129A |
|  | | | | | TANK EXTRACTOR 6mm | 9035099A |
|  | | | | | BAG FUEL HOSE 6x3 DIN 73379 B1 10m | 9036443A |







English
Deutsch

Spare Part Information Thermo Top Pro 120/150

Spare Part Information Thermo Top Pro 120/150

For price requests please refer to actual price list

Preise entnehmen Sie bitte der aktuell gültigen Preisliste.

| | 12V nominal Voltage | 24V nominal Voltage | 12kW Heating Power | 15kW Heating Power | Spare Part List for Thermo Top Pro 120/150 Übersicht Ersatzteile Thermo Top Pro 120/150 Application Parts Einzelteile zur Applikation | |
|---|---------------------|---------------------|--------------------|--------------------|---|---|
| | | | | | Spare Part Description <i>Ersatzteilbezeichnung</i> | Order number <i>Bestellnummer</i> |
|  | | | | | Bag Fuel | 9035490A |
|  2x 2x 2x | | | | | BAG CONNECTING PARTS FUEL 6mm | 9038207A |
|  | | | | | SP SPLASH GUARD CAP | 9036251A |
|  8x 2x | | | | | BAG WATER TTP 120-150 | 9035488A |
|  | | | | | SP Hose D20 | 1319631A |
| | | | | | BAG EXHAUST TTP 120-150 | 9035487A |
|  | | | | | EXHAUST FLEX PIPE D38_L1000 WITH END CAP | 1322674A |